SELECTED ENGINEERING PROBLEMS

NUMBER 3

INSTITUTE OF ENGINEERING PROCESSES AUTOMATION
AND INTEGRATED MANUFACTURING SYSTEMS

Krzysztof OLEK^{*}, Tomasz MACURA, Piotr PRZYSTAŁKA

Institute of Fundamentals of Machinery Design, Faculty of Mechanical Engineering,
Silesian University of Technology, Gliwice, Poland

^{*} krzysztofolek@gmail.com

SMALL SIZE AUTONOMOUS MOBILE ROBOT FOR FINDING THE WAY OUT OF A MAZE

Abstract: The main objective of this paper focuses on the prototype of a small size autonomous mobile robot that can be used in order to solve the maze problem. This kind of robots are often called micromouse. The paper presents the most important considerations deal with the design and realization of the robot. As a consequence, the mechanical, electrical and software components of the robot are briefly described. Moreover, the paper also includes some results of verification tests that were obtained in the international competitions.

1. Introduction

Path-finding algorithms are widely used in the modern world. They are present in computer games, transport, Internet, medicine and many others fields. Such algorithms are also needed for the navigation of autonomous mobile robots. There are many types of robots and specific tasks for them where path-finding methods must be applied [1]. One of the most common example of such robot is micromouse, that is the robot which finds its way out of a maze. In other words, the main task of micromouse robots is to find the shortest or quickest path to the target (the shortest path isn't always the quickest one). It is a very difficult problem to solve for the reason that a robot has to do this autonomously. Many people compete with others in international robotic competitions within micromouse category [2,3], to see who has the best solution to this problem. Their robots must be designed and built to be compliant with the rules of the micromouse competition [4]. The maze consists of up to 16 rows and 16 columns. A robot starts from one corner of the labyrinth and has to get to one of the centre-cells (for full-size maze these are segments with coordinates: (7,7), (7,8), (8,7), (8,8)). They have the limited time to do that – usually 10 or 15 minutes. Within this time they can make as many speed runs (each departure from the starting cell runs the new time measurement) as they manage or explore labyrinth. Evaluation of the effectiveness is done by measuring the quickest time needed to travel from the starting cell to any of the centre-cells.

This project has several assumptions. First of all, the robot must be autonomous. Second, it has to record an arrangement of visited maze cells. Third, after finding the shortest path, it has to go back to the starting cell. Then a robot has to make as many speed runs as it can manage and it should increase its maximum speed at each time. Fourth, a robot shouldn't touch the

walls – if it does and gets stuck, it has to be placed in the starting cell again. Fifth, varying lighting conditions must be taken into consideration.

The design of such a robot is a complex and time-consuming work. The main fields of this study are mechanic, electronic and software parts of the micromouse robot. During this process many concepts were made and many solutions were taken into consideration.

2. Micromouse robot design

The main guidelines of the design specification of the micromouse prototype are as follows:

- a micromouse robot has to be compliant with IEEE regulations [4];
- a robot shall not be larger either in length or in width than 168 mm x 168mm;
- a micromouse shall not jump over, fly over, climb, scratch, cut, burn, mark, damage or destroy the walls of the maze;
- the weight of the micromouse is unlimited.

Three different conceptions were introduced during the design process. The first of them was based on a four-wheel platform truck. Each one of two motors is connected to two wheels by the reduction gear and placed in the back of the robot. In this way better grip to the ground is achieved. On the other hand, the instant axis of rotation isn't placed in the centre of mass frame. This complicates the control of the robot. The second conception was a two wheel platform with a differential steering system [5]. Thanks to this the instant axis of rotation is placed in the centre of mass frame, hence the control of the robot is simplified. Finally, the third conception was based on the older type of micromouse robots. It was higher than platforms from previous conceptions. This conception was rejected due to the possible difficulties with stability in the high speed movement and high mass.

The second conception gained the best score in the multi-criteria analysis and therefore it was chosen as a basis for the further development process. The next step of designing a robot was to advance the concept. The decisions had to be made to determine a chassis material, the type of an electric drive/accumulator and the type of electric components. Due to morphological analysis the following decisions were made: laminate chassis used to print an electric circuit, direct current motors used as actuators, lithium polymer accumulators used as the power supply, electric components soldered using surface mount device technology.

The estimated mass of the robot was 0,3kg. Then the minimum torque and speed as required for motors were calculated. This allowed to compare different motors and choose the cheapest one which meets these criteria. After careful investigation Pololu HP micro metal gearbox (with the ratio 50:1) with extended shaft were selected. TB6612FNG driver was decided as the motor driver due to the high effectiveness and build-in safety circuits.

As a compromise between the cost, capabilities and size the ATmega32A was chosen as a main controller. To handle encoder signals two ATtiny13A were also needed. Encoders are required for motor feedback control. The next stage of the project was the sensor selection problem. The robot must be able to detect surrounding walls. For this purpose photodiode and phototransistor couples were chosen. As an addition to these sensors two digital Sharp sensors were also chosen as additional sensors. The last component was an accumulator. For the reason that this robot was designed as a prototype, a relatively capacious accumulator of 1000

mAh was selected to provide the long testing time without frequent battery charging (it last for more than 25 minutes of non-stop robot running).

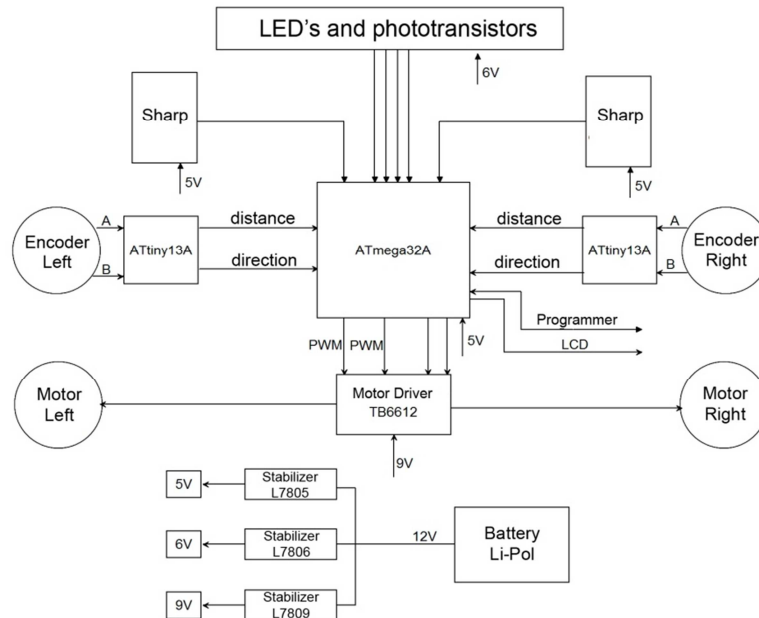

Fig. 1a. Simplified scheme of the electric circuit diagram

After selection process, the design of the circuit diagram and PCB layout was realized. A simplified electric scheme can be viewed in Fig. 1a, whereas the finished PCB layout design is shown in Fig. 1b.

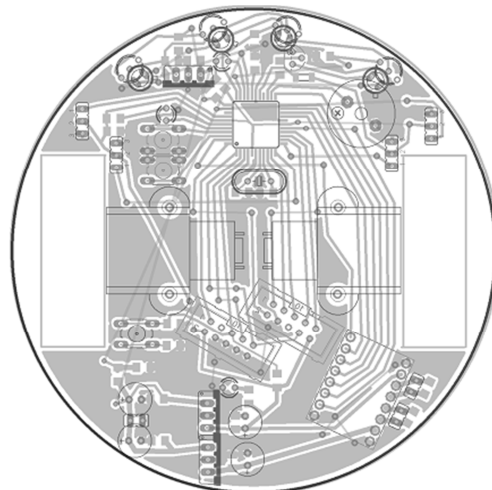

Fig. 1b. PCB layout design

To make testing process more efficient, the LCD display was placed at the top of a robot as shown in Fig. 2a. Together with buttons below it provides communication with user. As mentioned above, user can adjust parameters crucial to achieve the highest speed without losing control. LCD displays current parameters value and lets user change this values.

In Fig. 2b the specified placement of photodiode and phototransistor couples for the best possible wall detection are shown. These photo-couples point in the particular direction selected during testing process.

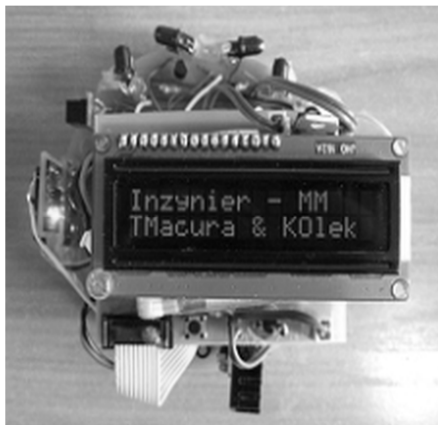

Fig. 2a. Micromouse robot Inżynier

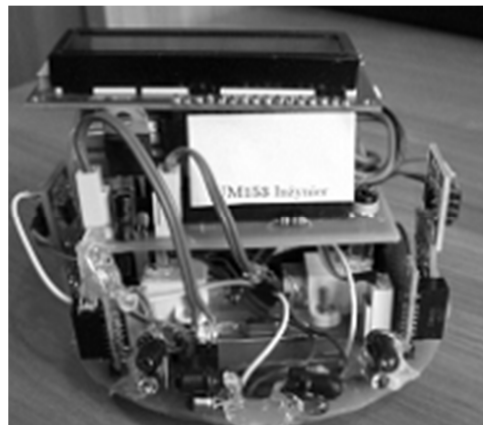

Fig. 2b. Micromouse robot Inżynier

3. Control system of micromouse robot

The next challenging problem in this project was to design the control system of the robot. The hardware layer of the robot control system was developed using the ATmega microcontroller (as the main computation unit) and the environment detection system with six optical sensors. It was decided that the functionality of the system would be as follows. The control system would have such subsystem as: the low-layer control system (DC motor controller), sensor data acquisition and processing system, autonomous inference system, map generation system for the explored area, a module for finding the shortest path to the target. The general concept of the robot control system is shown in Fig. 3.

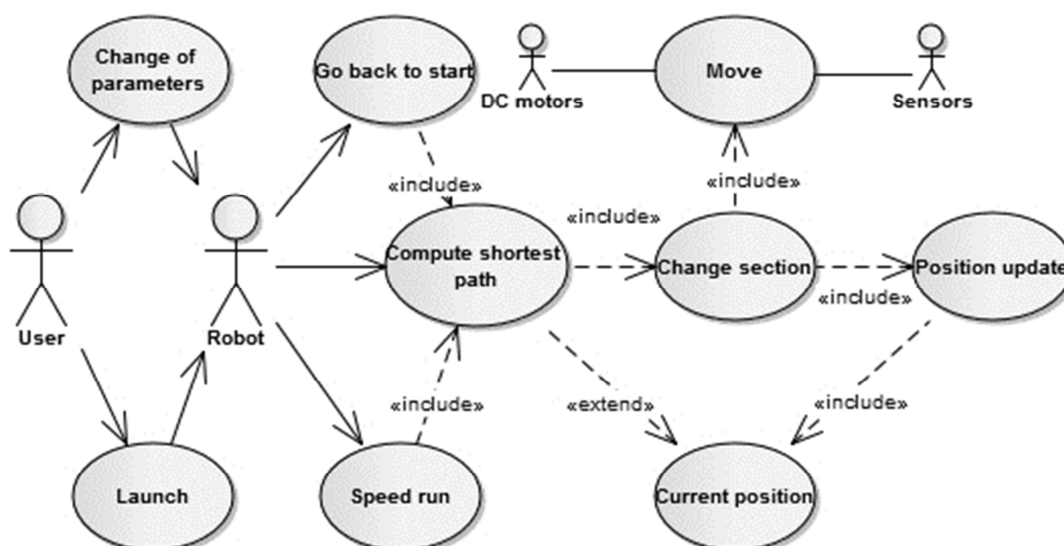

Fig. 3. General concept of the robot control system

As it was mentioned above, the robot is fully autonomous in terms of sensing, processing, inference and power supply. The user can only launch its program or change some parameters such as the maximal velocity of the robot or three separate constant parameters of the PID controller. When launched, the robot starts exploring the maze. The exploration stage consists of visiting cells with an unknown arrangement and recalculating the shortest path after each segment update. This stage lasts until any of the centre-cells are visited. Then the robot starts its way back to the starting position. During this travel the robot also tries to find the shortest path by visiting unexplored cells. When it reaches a starting cell, the robot starts a measuring stage. The aim of this stage is to achieve the best (shortest) possible travel time from the starting cell to any of the centre-cells. Time is measured from the departure from the starting cell to enter into any of target cells. In this stage the robot moves only along cells that belong to the shortest path.

Described stages consist mainly of translation from one cell to another. To do this, the robot has to move itself physically. It needs to use motors and sensors to do that and update the current cell arrangement and the actual position.

Previously described stages are also shown in Fig. 4. Waiting for a start signal is introduced for the reason of cleaning robot tires between each speed runs. One of the most important parts of control system design is module responsible for computing the shortest path. It is based on modified Bellman-Ford algorithm [3].

As it was referred to, the maze is made up of a 16 by 16 grid of cells. The target coordinates are known and the robot starts from the corner of the maze. Before start of the exploration process, all cells are assumed to have no walls (apart from walls that surrounds entire maze). Each time the robot moves to the new cell and updates its arrangement, computation of the shortest path restarts and move along this path is made.

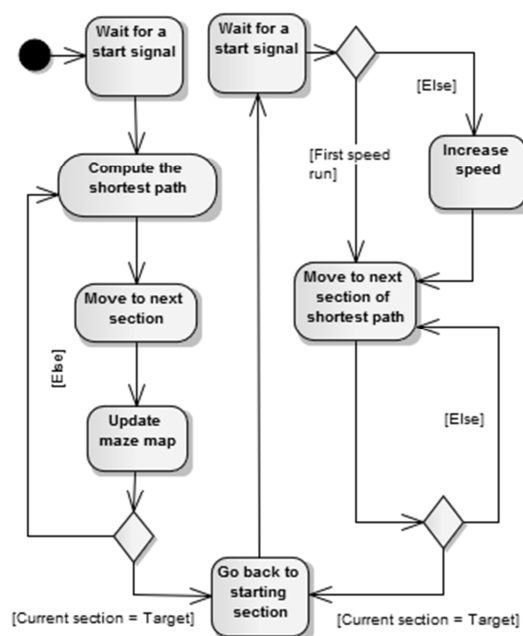

Fig. 4. Travelling algorithm

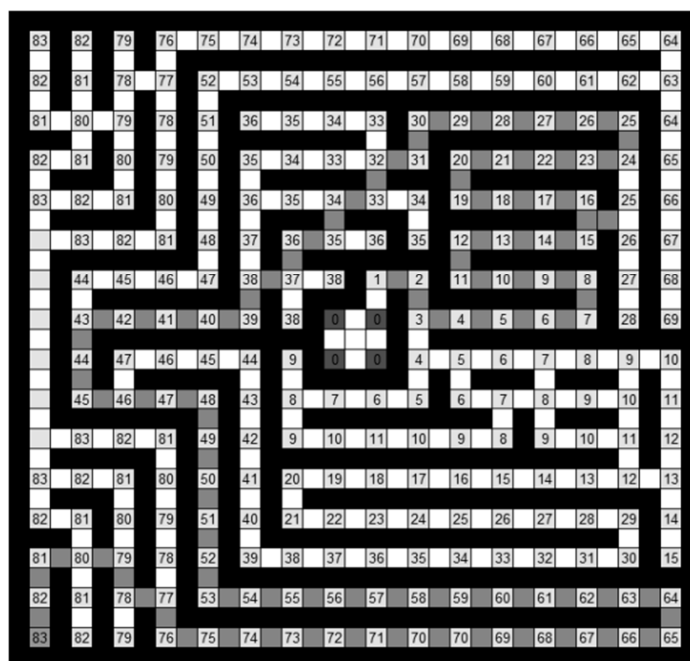

Fig. 5. Exemplary result of the flood-fill algorithm

The Bellman-Ford algorithm is also called the flood-fill algorithm. That is because we compute the shortest way in the same manner as the water poured into the maze would do. The path through which the water gets fastest into the middle-cells is the shortest path. In practice we simply number all cells that are available from the current cell as 1. All cells that are available from segments with the number 1 are given the number 2, and so on. When we assign a number to the cell which is our goal, we stop numbering cells. Then, we move in the opposite direction. Starting from the number given to the goal-cell we look for cells with descending numbers. These numbers create the shortest path. The exemplary result obtained using this algorithm is illustrated in Fig. 5.

4. Conclusion

The verification tests were conducted during Robotic Arena competition - Wrocław, 2011 [2] and also during Robomaticon competition - Warszawa, 2012 [3]. The designed robot proved its reliability, compliancy with assumptions and rules, as well as effectiveness. It took the second place in Robotic Arena competition and the third place in Robomaticon competition. The shortest time achieved by the robot in competitions was 1 min. 11.56 sec. The main conclusions of the authors are formulated as follows:

- Working on such a complex project needs effective time management.
- Teamwork accelerates the design process and helps in solving difficulties.
- Control system algorithms should be carefully selected in order to obtain the maximum performance.
- One of the hardest requirements is the autonomy of the robot.

References

1. Szmigielski A., Ciesielski P., Sawoniewicz J.: Elementy robotyki mobilnej. Wydawnictwo PJWSTK, Warszawa, 2004, (In Polish).
2. Home site of the competition Robotic Arena: <http://lirec.ict.pwr.wroc.pl/~arena/>, 21.10.2012
3. Home site of the competition Robomaticon <http://www.robomaticon.pl/pl/index>, 20.10.2012
4. IEEE Region 2 Student Activities Conference 2007 - Micromouse Competition Rules, http://www.ieee.uc.edu/main/files/sac2007/mm_rules.pdf - 20.10.2012.
5. Cormen, Thomas H.; Leiserson, Charles E., Rivest, Ronald L.: Introduction to Algorithms. MIT Press and McGraw-Hill., Third Edition. MIT Press, 2009, Section 24.1: The Bellman–Ford algorithm, pp. 651–655.